

End view

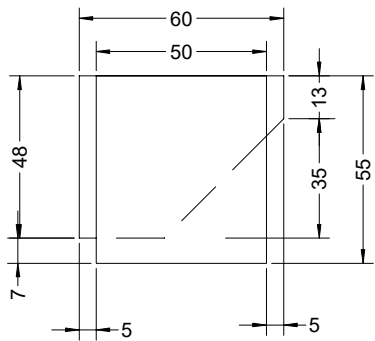

Centre

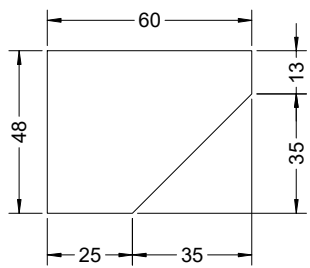

Ends

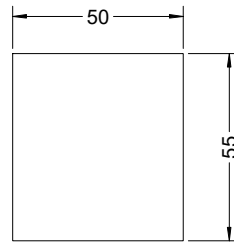

Overlay view

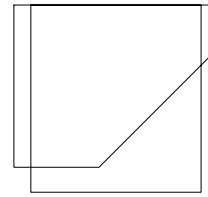

Dwg. MN4.1.02.15

Model MN4
Version 1.02
26 Sept 2017

C Pemberton-Pigott

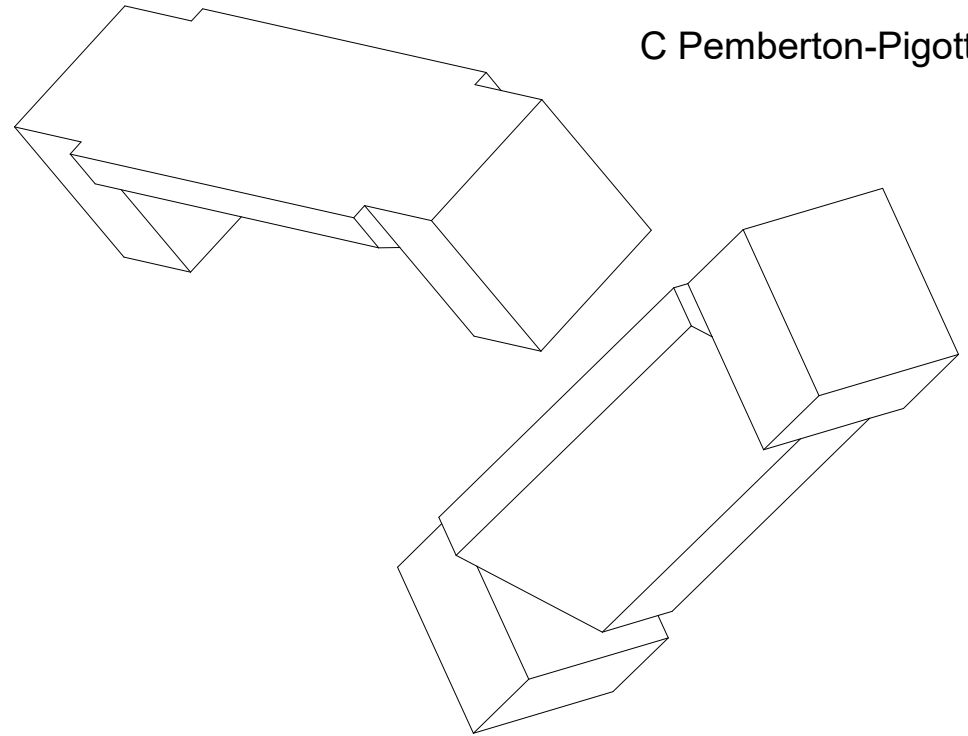
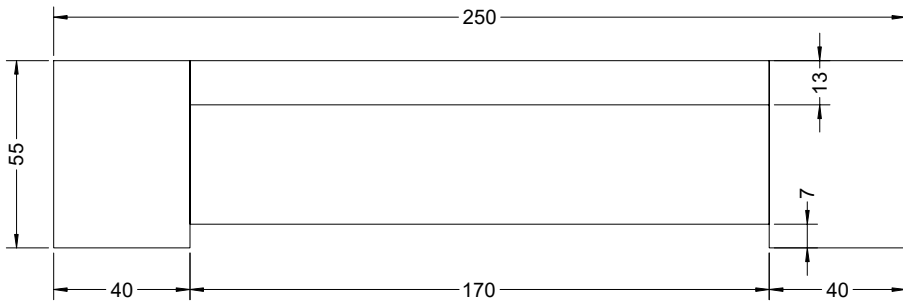

Bridge - Cast Iron

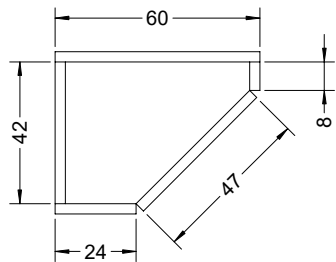

Bridge - 3mm welded

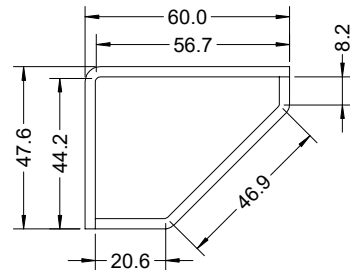

Bridge - 3mm bent

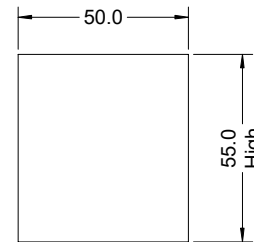

End piece

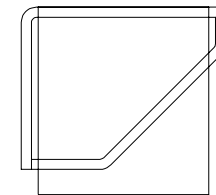

Overlay view