

Dwg. MN4.2.00.16

Model MN4
Version 2.00
2018-Feb-16

C Pemberton-Pigott

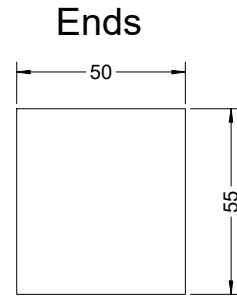
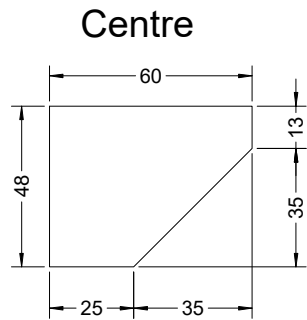
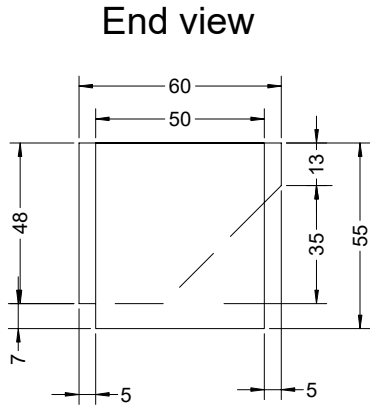

Overlay view

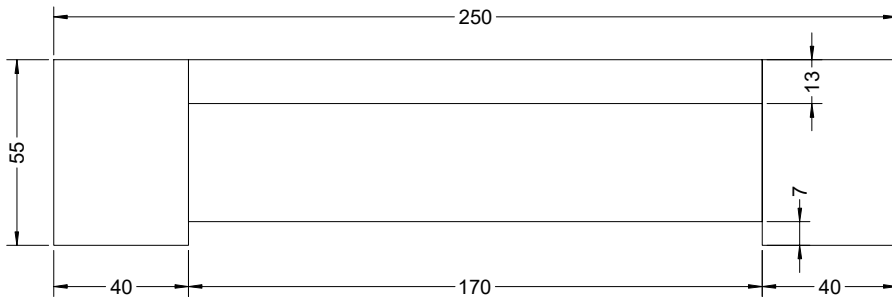
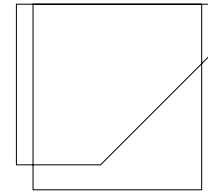

Bridge - Cast Iron

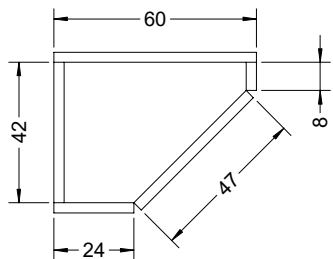
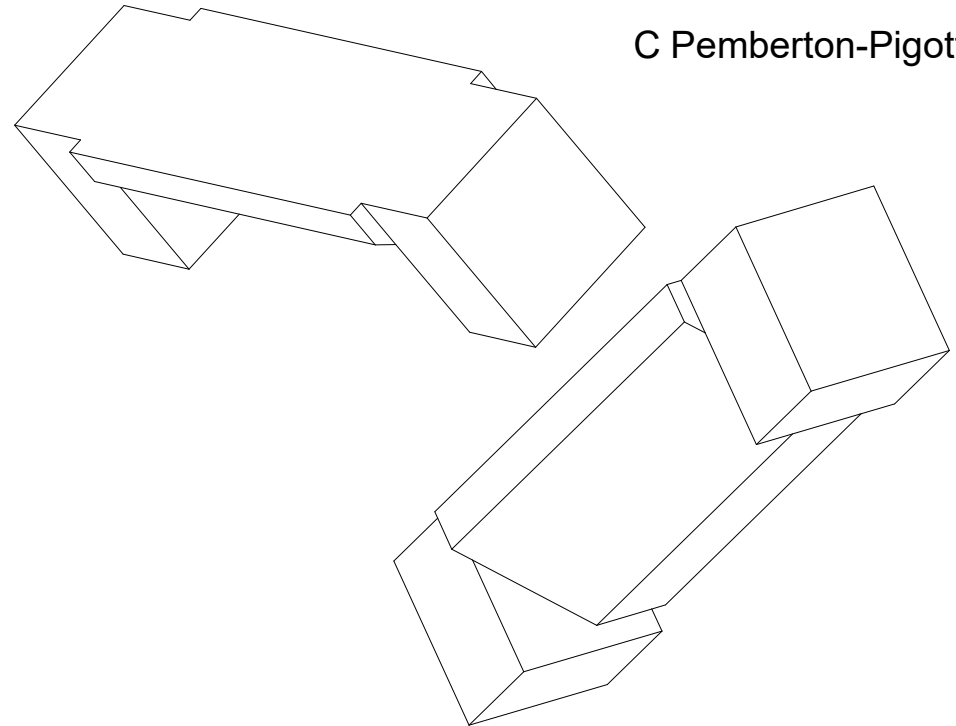

Bridge - 3mm welded

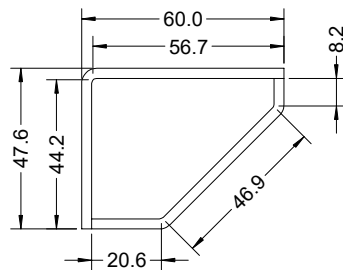

Bridge - 3mm bent

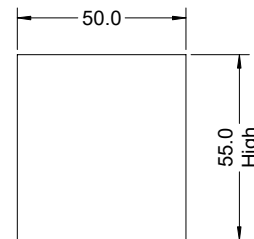

End piece

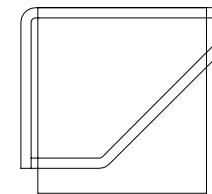

Overlay view